

# Heidelberger Stehgerät Jumbo

for children aged about 1 to 5 years  
suitable from about 65 cm to 110 cm

## Cost estimate

Sender / billing address

## Order

Address for dispatch

Purchaser

Date

Commission

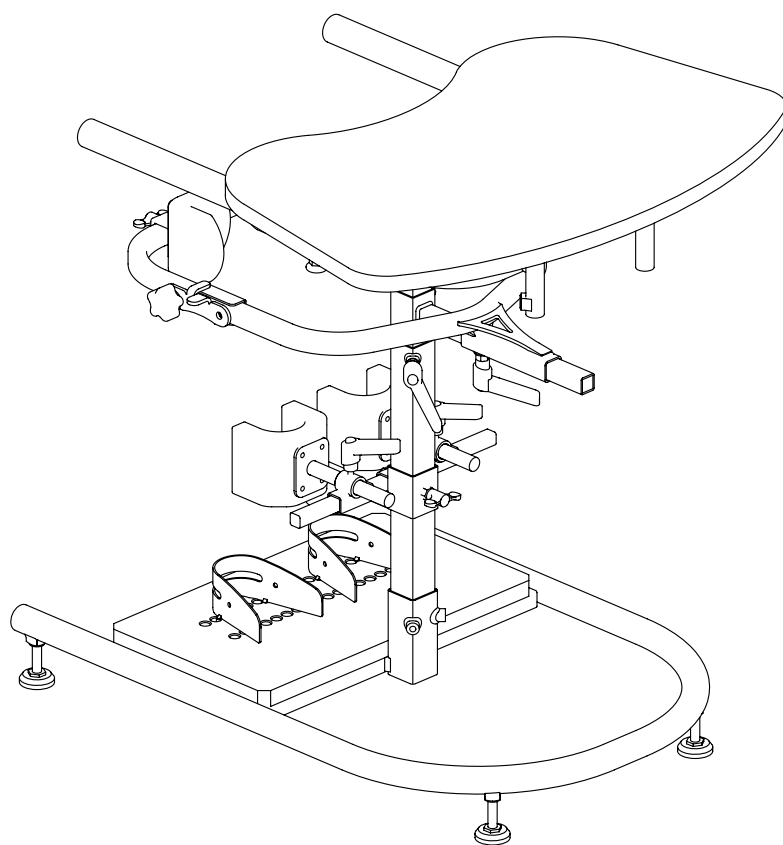

Hello, I am Jumbo.  
I am designed for children to  
support an upright standing  
position.



Figure does not comply with the base model and its accessories | Size tolerance of  $\pm 3\%$

### Base model

- Swivel arm frame
- Feet
- Sandals
- Knee cups
- Pelvic supports
- Tray
- Table adjustable for depth

### Type

- Type 109 max user weight: 40 kg
- max. user height: about 65 cm to 110 cm
- max. table height: 65 cm

Additional technical details available at [www.rehatec.com](http://www.rehatec.com) -> Downloads. Or send us your request by email, fax or letter.

Valid from 2023-01-01 until recalled. © Unauthorized duplication without prior permission of Rehatec GmbH is strictly prohibited.

Technical changes reserved. Our General Terms and Conditions apply, see [www.rehatec.com](http://www.rehatec.com).

By ordering our products, you confirm that you have read and accepted our General Terms and Conditions

Rehatec® GmbH, In den Kreuzwiesen 35, 69250 Schönau, T: +49 6228 9136-0, F: +49 6228 9136-99, [info@rehatec.com](mailto:info@rehatec.com), [www.rehatec.com](http://www.rehatec.com)

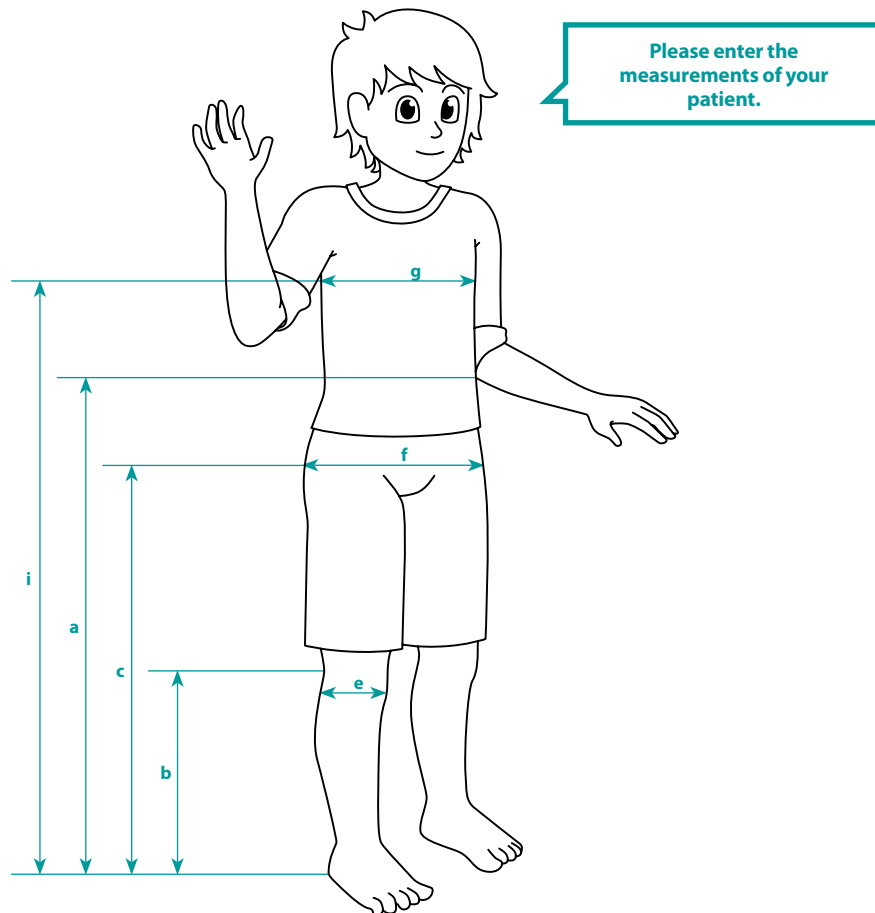

**\* CAUTION:**  
For technical reasons, the distance between the tray height (a) and the height of the pelvic middle (c) amounts to at least 15 cm!

Size tolerances  $\pm 3\%$

**Patient's muscle tone**  
Stereotypic movements (e.g. permanent body rocking)\*

\* If there are stereotypic movements, please check whether the stander requires any special customisation.

### Base model/user measurements

Table height* (a)	Knee height (b)	Height pelvic middle (c)	Knee width (e)	Pelvic width (f)	Chest width (g)	Height chest supports (i)	Body height	User weight
35 – 65 cm	12 – 32 cm	28 – 53 cm	6 – 13 cm	15 – 22 cm	16 – 28 cm	see chest supports p. 4	max. 110 cm	max. 40 kg
cm	cm	cm	cm	cm	cm	cm	cm	kg

### Equipment measurements

Max. width of entry	Total width	Total length	Inner tray width
39 cm	64 cm	80 cm	34 cm

<sup>(1)</sup> In case the centre column is 5 cm lower than the mount.

### Base model

**Upright Stander Jumbo for children**  
Code 109

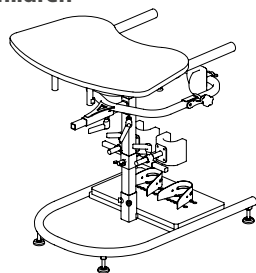

Base price

2.537,-€

### Cushion colours

- Light grey artificial leather (N20057)
- Anthracite artificial leather (N20058)

Other colours of artificial leather are available on request.

Please specify the colour of your Upright Stander Jumbo!

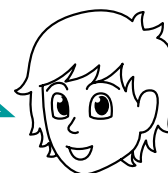

### Frame colours

Pure white (RAL 9010)	Bordeaux violet (RAL 4004)	Luminous green (RAL 6038)
Daffodil yellow (RAL 1007)	Ultramarine blue (RAL 5002)	Anthracite grey, matt (RAL 7016m)
Luminous yellow (RAL 1026)	Metallic traffic blue*	Metallic silver*
Pure orange (RAL 2004)	Pearl night blue, matt (RAL 5026)	Metallic anthracite*
Luminous orange (RAL 2005)	Water blue (RAL 5021)	Graphite black, matt (RAL 9011m)
Ruby red (RAL 3003)	Light green (RAL 6027)	Glossy jet black (RAL 9005g)
Pearl ruby red, matt (RAL 3032)	Yellow green (RAL 6018)	
Heather violet (RAL 4003)	Pearl green, matt (RAL 6035)	

\*no RAL colours

This is only an overview of colours. Find all details at [www.rehatec.com](http://www.rehatec.com).

### Frame

**Lockable castors , 75 mm**  
Code 1005593

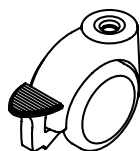

Set

270,-€

**Wall and furniture bumpers**  
Code 1018607

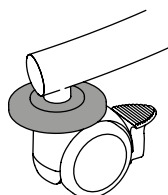

Set

117,-€

**Multi base frame**  
Code 110

incl. angle adjustable tray  
Angle range up to 20°

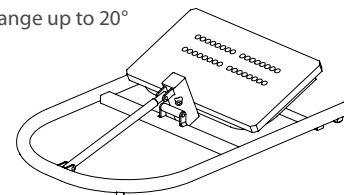

Extra charge

406,-€

### Therapy table

**Parallely adjustable armrests and a straight tray**  
Code 1016764

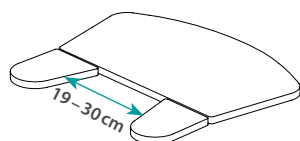

Extra charge

208,-€

**Armrests**  
Code 10026.j

Adjustable for width

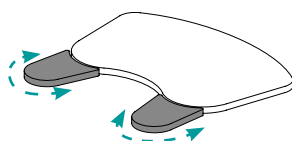

Extra charge

208,-€

**Angle adjustable tray**  
Code 1002041

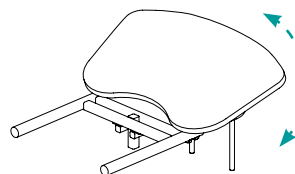

Incl. in Multi base frame

Extra charge

148,-€

**Grab rail**  
Code 1018742

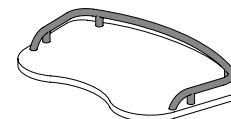

Set

162,-€

Additional technical details available at [www.rehatec.com](http://www.rehatec.com) -> Downloads. Or send us your request by email, fax or letter.

Valid from 2023-01-01 until recalled. © Unauthorized duplication without prior permission of Rehatec GmbH is strictly prohibited.

Technical changes reserved. Our General Terms and Conditions apply, see [www.rehatec.com](http://www.rehatec.com).

By ordering our products, you confirm that you have read and accepted our General Terms and Conditions

Rehatec® GmbH, In den Kreuzwiesen 35, 69250 Schönau, T: +49 6228 9136-0, F: +49 6228 9136-99, info@rehatec.com, www.rehatec.com

**Sandals**

**Sandals, screw-mounted**

Size	a	b	c	Item no.
0	9.5 cm	10.5 cm	5 cm	1016805
1	10.5 cm	13.5 cm	7 cm	1014407

**Straps**  
Code 1014394

**Recommended for screw-mounted sandals**

**Pair/ extra charge**      **67,-€**      **Pair**      **57,-€**

**Knee support mechanism**

**Knee cups adjustable in height, width and depth**  
Code 10022.j

**Pair/ extra charge**      **120,-€**

**Supports**

**Standard knee cups**

**Size complies with user measurements (6 – 13 cm)**

**Standard**

**Contoured knee cups**

Size	Knee width (f)	Item no.
1	8 cm	1018752
2	11,5 cm	1018753

**Pair/Extra charge**      **120,-€**

**Back support**  
Code 10018.j

**Extra charge**      **275,-€**

**Headrest**

Size	a	b	Item no.
1	16 cm	28 cm	1018744

**Only in combination with back support**

**Extra charge**      **320,-€**

**Chest support, curved**

Size	Code
0	1002268
1	1003622
2	1003623
3	1020576

Size	a	b	g	d
0	13 cm	11 cm	14.5 cm	9 cm
1	15 cm	11 cm	18.5 cm	9 cm
2	15 cm	11 cm	21.5 cm	9 cm
3	17 cm	12 cm	28 cm	11 cm

**Extra charge**      **243,-€**

**Sternum chest support, adjustable lateral supports incl.**

Size	g	b	c	d	e	Code
Mini	16–25 cm	15 cm	19.5 cm	12 cm	12 cm	1021966
0	20–28 cm	20 cm	20.5 cm	15.5 cm	12 cm	1021967

**Extra charge**      **467,-€**

**Contoured chest support, made to measure**  
Code 1010840

Height 1 (a) = \_\_\_\_\_ cm

Height 2 (b) = \_\_\_\_\_ cm

Width (g) = \_\_\_\_\_ cm

Depth (d) = \_\_\_\_\_ cm

**Extra charge**      **301,-€**

**For any customisations, please use the 'Modifications/ Customisations' form sheet available at [www.rehatec.com](http://www.rehatec.com) under 'Downloads'.**

**Please consider that the prices of spare parts might differ from the prices specified in this order form.**